



**Sorensen**  
**SFA Series DC Power**  
**Supplies**  
Operation Manual







## **About AMETEK**

AMETEK Programmable Power, Inc., a Division of AMETEK, Inc., is a global leader in the design and manufacture of precision, programmable power supplies for R&D, test and measurement, process control, power bus simulation and power conditioning applications across diverse industrial segments. From bench top supplies to rack-mounted industrial power subsystems, AMETEK Programmable Power is the proud manufacturer of Elgar, Sorensen, California Instruments and Power Ten brand power supplies.

AMETEK, Inc. is a leading global manufacturer of electronic instruments and electromechanical devices with annualized sales of \$2.5 billion. The Company has over 11,000 colleagues working at more than 80 manufacturing facilities and more than 80 sales and service centers in the United States and around the world.

## **Trademarks**

AMETEK is a registered trademark of AMETEK, Inc.

Other trademarks, registered trademarks, and product names are the property of their respective owners and are used herein for identification purposes only.

## **Notice of Copyright**

*SFA Series DC Power Supplies Operation Manual* © 2004-2008 AMETEK Programmable Power, Inc. All rights reserved.

## **Exclusion for Documentation**

UNLESS SPECIFICALLY AGREED TO IN WRITING, AMETEK PROGRAMMABLE POWER, INC. ("AMETEK"):

- (a) MAKES NO WARRANTY AS TO THE ACCURACY, SUFFICIENCY OR SUITABILITY OF ANY TECHNICAL OR OTHER INFORMATION PROVIDED IN ITS MANUALS OR OTHER DOCUMENTATION.
- (b) ASSUMES NO RESPONSIBILITY OR LIABILITY FOR LOSSES, DAMAGES, COSTS OR EXPENSES, WHETHER SPECIAL, DIRECT, INDIRECT, CONSEQUENTIAL OR INCIDENTAL, WHICH MIGHT ARISE OUT OF THE USE OF SUCH INFORMATION. THE USE OF ANY SUCH INFORMATION WILL BE ENTIRELY AT THE USER'S RISK, AND
- (c) REMINDS YOU THAT IF THIS MANUAL IS IN ANY LANGUAGE OTHER THAN ENGLISH, ALTHOUGH STEPS HAVE BEEN TAKEN TO MAINTAIN THE ACCURACY OF THE TRANSLATION, THE ACCURACY CANNOT BE GUARANTEED. APPROVED AMETEK CONTENT IS CONTAINED WITH THE ENGLISH LANGUAGE VERSION, WHICH IS POSTED AT [WWW.PROGRAMMABLEPOWER.COM](http://WWW.PROGRAMMABLEPOWER.COM).

## **Date and Revision**

December 2008 Revision F

## **Part Number**

M550292-01



## **Contact Information**

Telephone: 800 733 5427 (toll free in North America)  
858 450 0085 (direct)  
Fax: 858 458 0267  
Email: [sales@programmablepower.com](mailto:sales@programmablepower.com)  
[service@programmablepower.com](mailto:service@programmablepower.com)  
Web: [www.programmablepower.com](http://www.programmablepower.com)

This page intentionally left blank.

# Important Safety Instructions

Before applying power to the system, verify that your product is configured properly for your particular application.

 WARNING	<b>Hazardous voltages may be present when covers are removed. Qualified personnel must use extreme caution when servicing this equipment. Circuit boards, test points, and output voltages also may be floating above (below) chassis ground.</b>
 WARNING	<b>The equipment used contains ESD sensitive ports. When installing equipment, follow ESD Safety Procedures. Electrostatic discharges might cause damage to the equipment.</b>

Only *qualified personnel* who deal with attendant hazards in power supplies, are allowed to perform installation and servicing.

Ensure that the AC power line ground is connected properly to the Power Rack input connector or chassis. Similarly, other power ground lines including those to application and maintenance equipment *must* be grounded properly for both personnel and equipment safety.

Always ensure that facility AC input power is de-energized prior to connecting or disconnecting any cable.

In normal operation, the operator does not have access to hazardous voltages within the chassis. However, depending on the user's application configuration, **HIGH VOLTAGES HAZARDOUS TO HUMAN SAFETY** may be normally generated on the output terminals. The customer/user must ensure that the output power lines are labeled properly as to the safety hazards and that any inadvertent contact with hazardous voltages is eliminated.

Guard against risks of electrical shock during open cover checks by not touching any portion of the electrical circuits. Even when power is off, capacitors may retain an electrical charge. Use safety glasses during open cover checks to avoid personal injury by any sudden component failure.

Neither AMETEK Programmable Power Inc., San Diego, California, USA, nor any of the subsidiary sales organizations can accept any responsibility for personnel, material or inconsequential injury, loss or damage that results from improper use of the equipment and accessories.

## SAFETY SYMBOLS



WARNING  
Risk of Electrical Shock



CAUTION  
Refer to Accompanying Documents



Off (Supply)



Direct Current (DC)



Standby (Supply)



Alternating Current (AC)



On (Supply)



Three-Phase Alternating Current



Protective Conductor Terminal



Earth (Ground) Terminal



Fuse



Chassis Ground

This page intentionally left blank.



## Product Family: SFA Series DC Power Supplies

Warranty Period: Five Years

### WARRANTY TERMS

AMETEK Programmable Power, Inc. ("AMETEK"), provides this written warranty covering the Product stated above, and if the Buyer discovers and notifies AMETEK in writing of any defect in material or workmanship within the applicable warranty period stated above, then AMETEK may, at its option: repair or replace the Product; or issue a credit note for the defective Product; or provide the Buyer with replacement parts for the Product.

The Buyer will, at its expense, return the defective Product or parts thereof to AMETEK in accordance with the return procedure specified below. AMETEK will, at its expense, deliver the repaired or replaced Product or parts to the Buyer. Any warranty of AMETEK will not apply if the Buyer is in default under the Purchase Order Agreement or where the Product or any part thereof:

- is damaged by misuse, accident, negligence or failure to maintain the same as specified or required by AMETEK;
- is damaged by modifications, alterations or attachments thereto which are not authorized by AMETEK;
- is installed or operated contrary to the instructions of AMETEK;
- is opened, modified or disassembled in any way without AMETEK's consent; or
- is used in combination with items, articles or materials not authorized by AMETEK.

The Buyer may not assert any claim that the Products are not in conformity with any warranty until the Buyer has made all payments to AMETEK provided for in the Purchase Order Agreement.

### PRODUCT RETURN PROCEDURE

1. Request a Return Material Authorization (RMA) number from the repair facility (**must be done in the country in which it was purchased**):
  - **In the USA**, contact the AMETEK Repair Department prior to the return of the product to AMETEK for repair:  
Telephone: 800-733-5427, ext. 2295 or ext. 2463 (toll free North America)  
858-450-0085, ext. 2295 or ext. 2463 (direct)
  - **Outside the United States**, contact the nearest Authorized Service Center (ASC). A full listing can be found either through your local distributor or our website, [www.programmablepower.com](http://www.programmablepower.com), by clicking Support and going to the Service Centers tab.
2. When requesting an RMA, have the following information ready:
  - Model number
  - Serial number
  - Description of the problem

**NOTE:** Unauthorized returns will not be accepted and will be returned at the shipper's expense.

**NOTE:** A returned product found upon inspection by AMETEK, to be in specification is subject to an evaluation fee and applicable freight charges.

This page intentionally left blank.

## **FCC NOTICE**

---

This equipment has been tested and found to comply with the limits for a Class A digital device, pursuant to part 15 of the FCC Rules. These limits are designed to provide reasonable protection against harmful interference when the equipment is operated in a commercial environment.

This equipment generates, uses, and can radiate radio frequency energy and, if not installed and used in accordance with the instruction manual, may cause harmful interference to radio communications. Operation of this equipment in a residential area is likely to cause harmful interference in which case the user will be required to correct the interference at his own expense.

This page intentionally left blank.

## ABOUT THIS MANUAL

---

This manual has been written expressly for the Sorensen SFA Series of power supplies that have been designed and certified to meet the Low Voltage and Electromagnetic Compatibility Directive Requirements of the European Community.

Since the Low Voltage Directive is to ensure the safety of the equipment operator, universal graphic symbols have been used both on the unit itself and in this manual to warn the operator of potentially hazardous situations (see Safety page).

This page intentionally left blank.

# CONTENTS

SECTION 1 OVERVIEW .....	1-1
1.1 GENERAL DESCRIPTION .....	1-1
1.2 TECHNICAL SPECIFICATIONS .....	1-2
1.2.1 Environmental Characteristics .....	1-2
1.2.2 Electrical Characteristics .....	1-3
1.2.3 SFA Series Voltage and Current Specifications .....	1-4
1.2.4 Physical Characteristics .....	1-5
SECTION 2 INSTALLATION .....	2-1
2.1 INSPECTION .....	2-1
2.2 CONTENTS OF SHIPMENT .....	2-1
2.3 INPUT/OUTPUT CONNECTIONS .....	2-2
2.4 LOCATION AND MOUNTING .....	2-3
2.4.1 6U Chassis Removal from Rack .....	2-3
2.5 WIRE SELECTION .....	2-6
2.5.1 Wire Size .....	2-6
2.6 LOAD CONSIDERATIONS .....	2-8
2.6.1 Inductive Loads .....	2-8
2.7 OUTLINE DRAWINGS .....	2-8

SECTION 3 OPERATION .....	3-1
3.1 CONTROLS AND INDICATORS .....	3-1
3.1.1 Shaft Lock (Option) .....	3-4
3.2 LOCAL OPERATION .....	3-4
3.2.1 Floating and Polarized Output .....	3-5
3.2.2 Initial Setup .....	3-5
3.2.3 Current Mode Operation .....	3-6
3.2.4 Overcurrent Protection .....	3-6
3.2.5 Analog Control Connector (J1) .....	3-7
3.3 REMOTE CURRENT PROGRAMMING .....	3-11
3.4 REMOTE SENSING .....	3-12
3.5 REMOTE OUTPUT ON/OFF CONTROL .....	3-14
3.6 REMOTE OVERCURRENT SETPOINT .....	3-15
3.7 REMOTE SHUTDOWN (S/D) .....	3-16
3.8 MASTER/SLAVE OPERATION .....	3-16
3.8.1 Parallel Operation .....	3-16
SECTION 4 VERIFICATION AND CALIBRATION .....	4-1
4.1 INTRODUCTION .....	4-1
4.1.1 Verification and Calibration Cycle .....	4-1
4.1.2 Preparation .....	4-1
4.2 STANDARD VERIFICATION AND CALIBRATION PROCEDURE .....	4-2
4.2.1 Current Mode .....	4-2
4.2.2 Resistor Programming Current Sources .....	4-3
4.3 ISOLATED ANALOG (OPTION) VERIFICATION AND CALIBRATION PROCEDURE .....	4-3
4.3.1 Current Mode .....	4-4
SECTION 5 MAINTENANCE .....	5-1
5.1 INTRODUCTION .....	5-1



5.2	PREVENTIVE MAINTENANCE .....	5-1
5.3	FUSES.....	5-3

## LIST OF TABLES

Table 2-1.	5kW to 15kW and 20kW to 30kW Series Input/Output Connectors .....	2-4
Table 2-2.	Input Connections .....	2-4
Table 2-3.	Output Connections .....	2-4
Table 2-4.	Minimum Wire Size .....	2-6
Table 2-5	Wire Resistance and Voltage Drop .....	2-7
Table 2-6	Maximum AC Current Ratings .....	2-8
Table 2-7	Recommended Lugs .....	2-8
Table 2-8.	Recommended Sense Connector Tools .....	2-8
Table 3-1.	ANALOG CONTROL Connector (J1), Designations and Functions.....	3-10
Table 5-1.	Recommended Annual Inspection .....	5-2
Table 5-2.	Fuse Values .....	5-3

## LIST OF FIGURES

Figure 1-1.	Model Number Decoding .....	1-1
Figure 2-1.	SFA Series Outline Drawing, 3U Models, 5kW to 15kW.....	2-9
Figure 2-2.	SFA Series Outline Drawing, 6U Models, 20kW to 30kW.....	2-10
Figure 3-1.	Front Panel Controls and Indicators (3U model shown) .....	3-1
Figure 3-2.	Rear Panel Connectors (3U model shown) .....	3-3
Figure 3-3.	Shaft Lock.....	3-4
Figure 3-4.	ANALOG CONTROL Connector (J1) Pin-out .....	3-8
Figure 3-5.	Remote Current Programming Using Resistance .....	3-11
Figure 3-6.	Remote Current Programming Using 0-5 VDC or 0-10 VDC Voltage Source.....	3-12
Figure 3-7.	Remote Sensing Operation at the Load * .....	3-13
Figure 3-8.	Remote On/Off Control by Contact Closure.....	3-14
Figure 3-9.	Remote On/Off Using Isolated AC or DC Voltage Source .....	3-14
Figure 3-10.	Remote On/Off Using Isolated TTL/CMOS Voltage Supply.....	3-15
Figure 3-11.	Remote Overcurrent Set Using DC Voltage Source .....	3-15
Figure 3-12.	Remote Shutdown Using DC Voltage Source.....	3-16
Figure 3-13.	Master/Slave Connection.....	3-17
Figure 4-1.	Precision Current Shunt.....	4-2
Figure 4-2.	Potentiometer Locations .....	4-5



# SECTION 1 OVERVIEW

## 1.1 GENERAL DESCRIPTION

The Sorensen SFA Series power supplies are designed specifically for high power laser driver applications requiring variable DC current sources with fast output response times.

A variety of user interfaces are available, ranging from manual front-panel control and standard non-isolated remote analog control, to optional GPIB or isolated remote analog control.

NOTE: The SFA Series power supplies are *not* designed for series operation and therefore must not be used as such.

Figure 1-1 decodes the SFA Series model number.

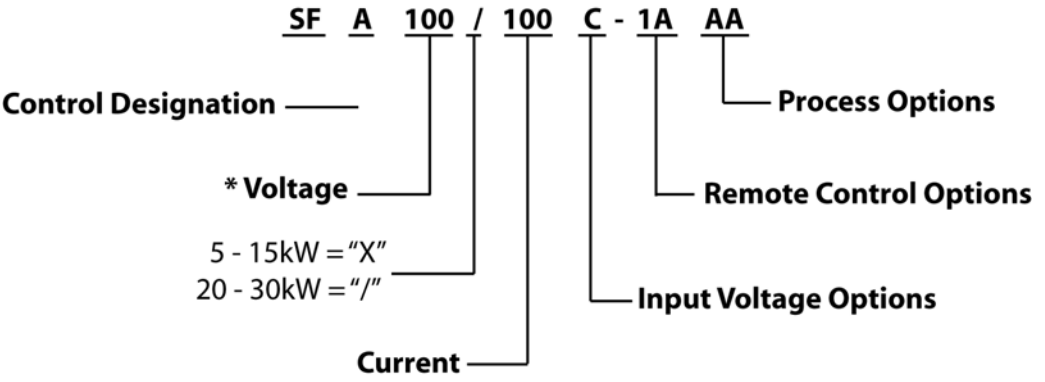

\* No voltage control. Value is the max voltage that the supply can source current.

**Figure 1-1. Model Number Decoding**

## 1.2 TECHNICAL SPECIFICATIONS

The following sections provide environmental, electrical, and physical characteristics for the SFA Series power supplies.

Note: Specifications are subject to change without notice.

Note: The SFA Series power supplies are intended for indoor use only. Please refer to Section 2.4 for use/location requirements.

### 1.2.1 ENVIRONMENTAL CHARACTERISTICS

Parameter	Specification
Temperature Coefficient	0.03%/°C of maximum output current rating for current set point.
Ambient Temperature	
Operating	0 to 50°C
Storage	-25° to 65°C
Cooling	Internal fans; vents on sides and rear. (Units may be stacked without clearance above or below).
Humidity	95% maximum, non-condensing, 0 to 50°C; 45°C maximum wet-bulb temperature
Altitude	Operating full power available up to 5,000 feet (1,524m), derate 10% of full power for every 1,000 feet higher non-operating to 40,000 feet (12,192m)

## 1.2.2 ELECTRICAL CHARACTERISTICS

Parameter	Specification
Input Power	
Voltage (Standard)	208/220 VAC $\pm$ 10% (tested to 187-242 VAC)
Voltage (Options)	380/400 VAC $\pm$ 10% (tested to 342-440 VAC) 440/480 VAC $\pm$ 10% (tested to 396-528 VAC)
Frequency	47 to 63 Hz
Phases	3-phase, 3-wire plus ground. Not phase rotation sensitive. Neutral not used.
Front Panel Meter Accuracy	
Voltage	$\pm$ 0.5% of full-scale + 1 digit
Current	$\pm$ 0.5% of full-scale + 1 digit
Load Regulation	(Specified at no load to full load, nominal AC input)
Current	0.1% of maximum output current
Line Regulation	(Specified $\pm$ 10% of nominal AC input, constant load)
Current	0.05% of maximum output current
Current Ripple	1% p-p of full-scale current
Transient Response	The output current will recover to within 1% of the set current value within 1ms for a 10 to 100% or 100% to 10% step load change
Output Slew Rate	(10-90% current, full resistive load, nominal AC input): 250A/ms (400A/ms typical) rise, 200A/ms typical fall; 160V models, 87A/ms/5kW (145A/ms/5kW typical), rise, 60A/ms, typical, fall
Current Overshoot	Maximum 8% of full-scale for 0 to 100% change into a resistive load
Stability	$\pm$ 0.05% of set point after 8-hr. warm-up at fixed line, load, and temperature.
Remote Control/Monitor	On/Off control via contact closure, 6-120 VDC or 12-240 VAC, and TTL or CMOS switch, current monitor, OCP limit set, summary fault status
Power Factor	>0.9 typical for 208/220VAC input >0.78 typical for 380/400VAC input >0.7 typical for 440/480VAC input
Efficiency	87% typical at full load, nominal line

Parameter	Specification
<b>REMOTE PROGRAMMING</b>	
Accuracy	
CONSTANT CURRENT	±0.8% of full-scale output
Overcurrent Protection	±1% of full-scale output
Resistive Control Input	
CONSTANT CURRENT (0-100%)	0–5 kΩ
Voltage Control Input	
Constant Current (0-100%)	0–5 VDC or 0–10 VDC
Overcurrent Protection (OCP) (0-110%)	0–5.5 VDC
Remote Sensing	Terminals are provided to sense output voltage at point of load for accurate voltage measurement.
Overvoltage Protection	Fixed at approximately 110% of the rating compliance voltage. Reset requires cycling the front panel standby power switch off/on
<b>ISOLATED ANALOG CONTROL (OPTION)</b>	
Input to Output Isolation	600 V Compliant with maximum terminal float voltage. Recommended operation under SELV normal conditions. (Standard Non-isolated Analog programming 300V maximum. Recommended operation under SELV normal conditions).

### 1.2.3 SFA SERIES VOLTAGE AND CURRENT SPECIFICATIONS

<b>Ratings</b>						
<b>Voltage</b>	<b>5 kW</b>	<b>10 kW</b>	<b>15 kW</b>	<b>20 kW</b>	<b>25 kW</b>	<b>30 kW</b>
0-60V	0-83A	0-167A	0-250A	0-333A	0-417A	0-500A
0-100V	0-50A	0-100A	0-150A	0-200A	0-250A	0-300A
0-160V	0-31A	0-63A	0-94A	0-125A	0-156A	0-188A

**NOTE:** Contact factory for availability on specific models

## 1.2.4 PHYSICAL CHARACTERISTICS

<b>Dimension</b>	<b>3U Models</b>	<b>6U Models</b>
Width	19.00 in (48.3 cm)	19.00 in (48.3 cm)
Depth	25.12 in (63.8 cm)	25.12 in (63.8 cm)
Height	5.25 in (13.3 cm)	10.5 in (26.7 cm)
Weight	80 lbs (36 kg) maximum	160 lbs (73 kg) maximum

This page intentionally left blank.



# SECTION 2 INSTALLATION

## 2.1 INSPECTION

Inspect the shipping carton for possible damage before unpacking the unit. Carefully unpack the equipment. Save all packing materials until inspection is complete. Verify that all items listed on the packing slips have been received. Visually inspect all exterior surfaces for broken knobs, connectors, or meters. Inspect for dented or damaged exterior surfaces. External damage may be an indication of internal damage. If any damage is evident, immediately contact the carrier that delivered the unit and submit a damage report. Failure to do so could invalidate future claims. Direct repair issues to Customer Service at 1-800-733-5427.

## 2.2 CONTENTS OF SHIPMENT

Depending on the model, configuration, and options available for your SFA Series power supply, the ship kit may include additional parts and accessories. At a minimum, the ship kit that accompanies your SFA Series power supply includes the following items:

- AMETEK manuals CD-ROM, Part No. M550008-01 containing the SFA Series DC Power Supplies Operation Manual Part No. M550292-01 (this manual)
- Sense mating connector (Molex P/N 39-01-4031) with loose contacts (Molex P/N 39-00-0182)
- J1 mating connector (Cinch P/N DB25P or equivalent) normally shipped attached to rear panel J1
- Back shell for J1 (DB25) mating connector (Cinch P/N DCH-B-001 or equivalent)

- Screw, lock washer, and nut for AC input and DC output connections:  
5–15 kW: ¼-20UNC-2B x ½", 4 ea AC input only  
20–30 kW: 3/8-16UNC-2B x 7/8", 6 ea
- Black screw, 10-32UNC-2B x ½", front panel rack fastener:  
5–15 kW: 4 ea  
20–30 kW: 8 ea

If any of these parts are missing, please contact Customer Service at 1-800-733-5427.

## 2.3 INPUT/OUTPUT CONNECTIONS



### WARNING!

High voltage present! Risk of electrical shock. Do not remove cover. Refer to qualified service personnel.

Table 2–1 lists all external connections for the SFA Series models. Table 2–2 and Table 2–3 provide input and output connection descriptions by power supply type.

For permanently connected equipment, a readily accessible disconnect device shall be incorporated in the fixed wiring. For pluggable equipment, the socket outlet shall be installed near the equipment and shall be easily accessible.

Take precautions to ensure that the concentration of ozone is limited to a safe value. The recommended long-term exposure limit for ozone is 0.1 PPM (0.2 mg/m<sup>3</sup>).



### CAUTION!

Do not use the SFA power supplies in series operation.



### CAUTION!

For proper connection to the mains, a 100–amp circuit breaker or fuse for 3U units and a 200–amp circuit breaker or fuse for 6U units is required.



### WARNING!

Under no condition should the negative output terminal exceed 300V to earth ground for non-isolated Analog programming. (600V for supplies with the Isolated Analog option installed.)

**CAUTION!**

Floating the negative output terminal floats the power supply's internal control circuitry common level to the same potential as the negative output terminal. On a standard non-isolated supply the common of the analog control connector (J1) floats at the same potential as the negative output terminal. Damage may occur if the non-isolated analog control connector of a supply is connected to an external ground referenced input/output device. Such a connection creates ground loop currents. To correct ground loop problems the Isolated Analog option is advised in order to isolate the external ground reference signals from the internal control circuitry of the supply.

## 2.4 LOCATION AND MOUNTING

**WARNING!**

To reduce the risk of fire or electrical shock, install the SFA Series unit in a temperature and humidity controlled indoor area, free of conductive contaminants.

**CAUTION!**

The unit should be provided with proper ventilation. The rear and both sides of the unit should be free of obstructions. To ensure proper airflow, a minimum 4" clearance from the rear air outlet is required. The unit should not be installed in a raised ambient temperature greater than 50°C.

**CAUTION!**

This unit is intended for installation in a protected environment. No user serviceable parts inside. Service to be performed by qualified personnel only.

The SFA Series models are designed for mounting in a standard 19-inch equipment rack. If additional instrumentation is mounted in the rack, no additional clearance is required between the SFA series and other power supplies or instruments.

1. Support the unit using rack mount slides or appropriate L brackets (suggested parts are listed below).

Rack Mount Slide Kit:

- 5–15kW units: P/N K550212-01
- 20–30kW units: P/N K550213-01

2. Secure the unit in place using the screws provided.

### 2.4.1 6U CHASSIS REMOVAL FROM RACK

The slides have a Front Disconnect Feature and lock at full extension.

To return the chassis back into the rack from full extension, depress the flat steel spring inward (located on the slides) and push the chassis back.

To disconnect and remove the chassis from the rack, depress the flat steel spring inward (located on the slides) and pull the chassis forward.



**WARNING!**

The 6U SFA Series unit weighs up to 160 lbs (73kg) depending on the model. A minimum three-person lift is required!

When the chassis is at full extension, the flat springs are located approximately one (1) inch behind the front EIA RETMA rails. Access the springs with a flat blade screwdriver or similar device to release from lockout or to remove the chassis from the rack.

The slides can be mounted to the chassis with this spring oriented on the top or the bottom of the slide.

Table 2–1 provides details of the SFA Series input and output connectors and their functions.

Connector	Function	Connects To
Pos. Threaded Stud Neg. Threaded Stud Pos. Bus Bar Neg. Bus Bar	Output Power: 3U models (see Table 2–3)  6U models (see Table 2–3)	User load(s)
ANALOG CONTROL Connector (J1)	Control Interface	See Table 3–1 for description
Sense Connector	Used for remote sense	Refer to Section 3.4
Parallel In-Out	Used for parallel operation	Refer to Section 3.8

**Table 2–1. 5kW to 15kW and 20kW to 30kW Series Input/Output Connectors**

Power Supply Type	Connection Description
5 kW to 15 kW	Bus Bar with holes for 1/4"–20 bolts
20 kW to 30 kW	Bus Bar with holes for 3/8"–16 bolts

**Table 2–2. Input Connections**

Power Supply Type	Connection Description
5 kW to 15 kW ≥60V	3/8" Threaded Studs
20 kW to 30 kW ≥60V	Bus Bar with holes for 3/8" bolts

**Table 2–3. Output Connections**

**CAUTION!**

Prevent damage to the unit: follow torque specifications, use correct size wire ferrule (if used), and proper size ferrule crimping tool.

**TORQUE SPECIFICATIONS**

- The unit's Phoenix Connectors require 18 in-lb to 20 in-lb (2 Nm to 2.3 Nm) torque.
- Wire ferrules are recommended; their size must match the wire gauge.
- Crimp tool size must be appropriate to the ferrule size.
- Wire insulation should be stripped back no more than 5/8 inch for the ferrule.

For more information on this AC input connector, please look up Phoenix Contact part number HDFKV 16 at [www.phoenixcontact.com](http://www.phoenixcontact.com).

## 2.5 WIRE SELECTION

Care must be taken to properly size all conductors for the input and output of the power supply. This section provides guidance in the selection of wire size. Note that cables with Class B or C stranding should be used. Fine stranded cables should not be used unless crimp-on lugs or ferrules are used that are approved for fine stranded cables.

### 2.5.1 WIRE SIZE

The tables below will assist in determining the appropriate wire size for both the input and output connections Table 2–4 below gives *minimum* recommended wire size. This table is derived from the National Electrical Code; it is for reference only. Local laws and conditions may have different requirements. Note that these recommendations are for copper wire only. For higher ratings, wires can be paralleled; refer to the National Electrical Code.

Size	Temperature Rating of Copper Conductor			
	60°C	75°C	85°C	90°C
AWG MCM	Types: RUW, T, TW, UF	Types: FEPW, RHW, RH, RUH, THW, THWN, XHHW, USE, ZW	Types: V, MI	Types: TA, TBS, SA, AVB, SIS, FEP, FEPB, RHH, THHN, XHHW
	<b>Current Rating</b>			
14	20	20	25	25
12	25	25	30	30
10	30	35	40	40
8	40	50	55	55
6	55	65	70	75
4	70	85	95	95
3	85	100	110	110
2	95	115	125	130
1	110	130	145	150
0	125	150	165	170
00	145	175	190	195
000	165	200	215	225
0000	195	230	250	260

**Table 2–4. Minimum Wire Size**

When determining the optimum cable specification for your power applications, the same engineering rules apply whether going into or out of an electrical

device. Thus, this guide applies equally to the input cable and output cable for this Sorensen instrument and application loads.

Power cables must be able to safely carry maximum load current without overheating or causing insulation destruction. It is important to everyday performance to minimize IR (voltage drop) loss within the cable. These losses have a direct effect on the quality of power delivered to and from instruments and corresponding loads.

When specifying wire gauge, consider the operating temperature. Wire gauge current capability and insulation performance drops with the increased temperature developed within a cable bundle and with increased environmental temperature. Thus, short cables with generously derated gauge and insulation properties are recommended for power source applications.

Be careful when using published commercial utility wiring codes. These codes are designed for the internal wiring of homes and buildings and accommodate the safety factors of wiring loss, heat, breakdown insulation, aging, etc. However, these codes consider that up to 5% voltage drop is acceptable.

Such a loss directly detracts from the quality performance specifications of this Sorensen instrument. Also, consider how the wiring codes apply to bundles of wire within a cable arrangement.

In high performance applications requiring high inrush/ transient currents, additional consideration is required. The cable wire gauge must consider peak currents, which may be up to ten times the average values. An underrated wire gauge adds losses, which alter the inrush characteristics of the application and thus the expected performance.

Table 2–5 presents wire resistance and resulting cable voltage drop at maximum rated current.

<b>Column 1</b>	<b>Column 2</b>	<b>Column 3</b>	<b>Column 4</b>
<b>Size (AWG)</b>	<b>Amperes (Maximum)</b>	<b>Ohms/100 Feet (One Way)</b>	<b>Voltage Drop/100 Feet (Column 2 x Column 3)</b>
14	20	0.257	5.14
12	25	0.162	4.05
10	30	0.102	3.06
8	40	0.064	2.56
6	55	0.043	2.36
4	70	0.025	1.75
2	95	0.015	1.42
1/0	125	0.010	1.25
3/0	165	0.006	1.04

**Table 2–5 Wire Resistance and Voltage Drop**

Refer to Table 2–6 for AC input current requirements and Section 1.2.3 for output current requirements.

Input V	Input Line Current						Unit of Measure
	5 kW	10 kW	15 kW	20 kW	25 kW	30kW	
200-240VAC	21	41	62	83	103	124	Amps AC per phase
340-440VAC	14	27	40	54	67	80	
480VAC	13	26	39	52	65	78	

**Table 2–6 Maximum AC Current Ratings**

Refer to Table 2–7 for input/output lug recommendations.

Lug Manufacturer	3U Models Input/Output	6U Models Input/Output
Panduit	“PN” Series or equivalent	“LCA” Series or equivalent

**Table 2–7 Recommended Lugs**

The recommended tools for installation and extraction of the sense connector are listed next, in Table 2–8.

Tool	Manufacturer	Manufacturer P/N
Crimping Device	Molex	11-01-0197
Extracting Device	Molex	11-03-0044

**Table 2–8. Recommended Sense Connector Tools**

## 2.6 LOAD CONSIDERATIONS

### 2.6.1 INDUCTIVE LOADS

To prevent damage to the power supply from inductive loads, the SFA has incorporated a overvoltage shutdown circuit on the output. The overvoltage is preset for approximately 110% of the total rated output voltage. If the output voltage exceeds this amount for more than a few milliseconds, the output will shutdown. In order to reset the unit, the input standby switch, will need to be cycled on and off.

## 2.7 OUTLINE DRAWINGS

Figure 2-1 and Figure 2–2, next, show the outlines and overall dimensions of the 3U and 6U models of the SFA Series product line.





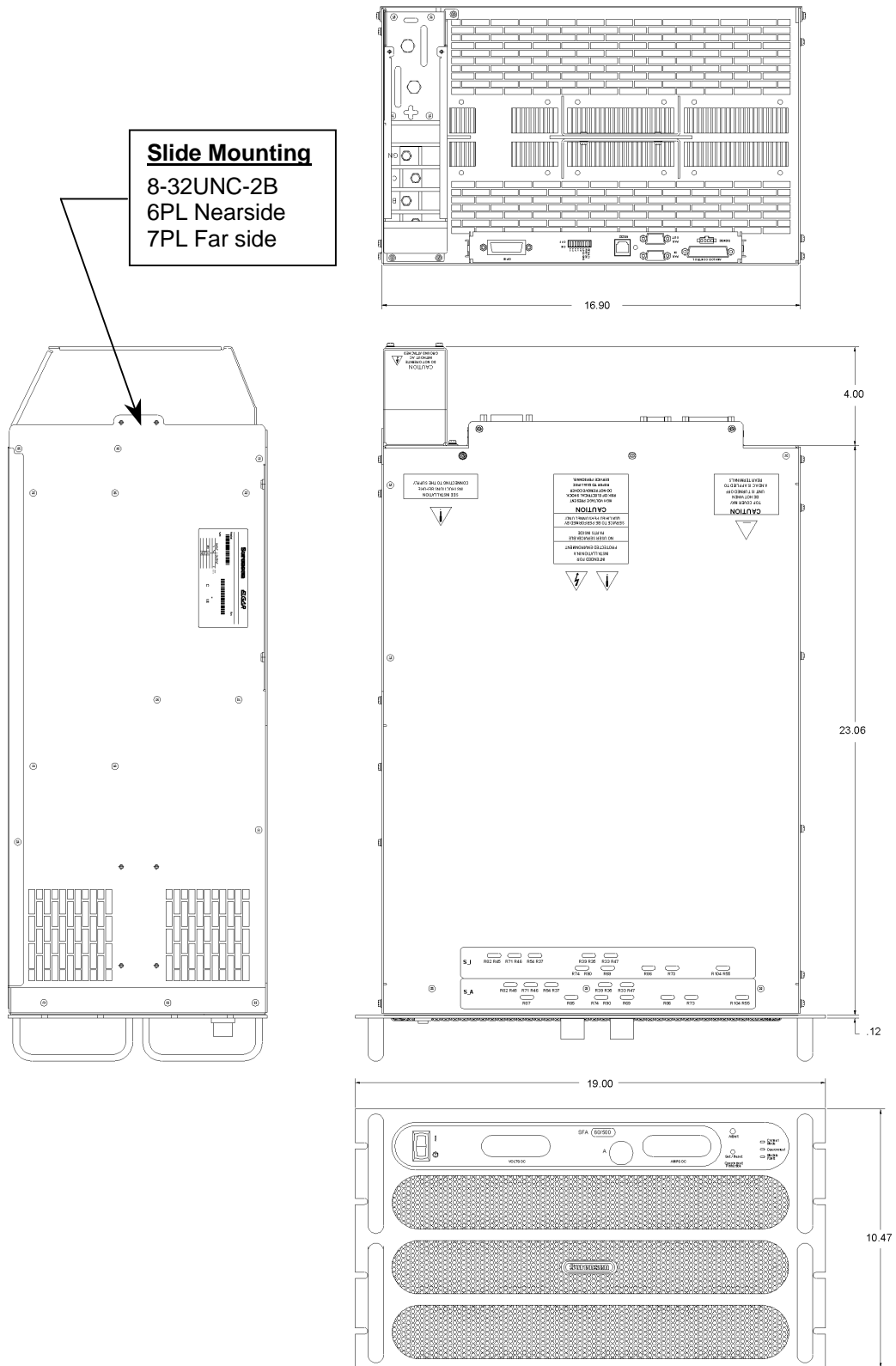
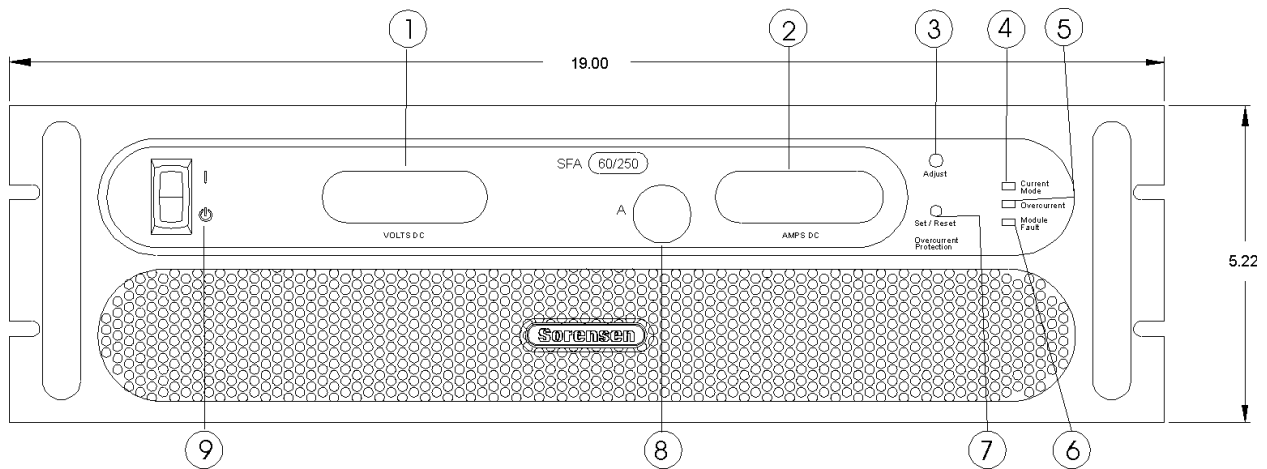

**Figure 2–2. SFA Series Outline Drawing, 6U Models, 20kW to 30kW**

## SECTION 3 OPERATION

### 3.1 CONTROLS AND INDICATORS

Refer to Figure 3-1 and the corresponding descriptions below for an explanation of front panel controls and indicators on the SFA Series power supply.



**Figure 3-1. Front Panel Controls and Indicators (3U model shown)**

- 1 Voltage Display: 3½ digit green LED display indicates the DC output voltage of the supply.
- 2 Current Display: 3½ digit green LED display indicates the DC output current of the supply. Display indicates the OCP setting when the SET/RESET OVERCURRENT PROTECTION button is pushed.
- 3 ADJUST Overcurrent Potentiometer: Adjusts the overcurrent trip level.

- 4 CURRENT MODE Indicator: Green LED lights when in the constant-current mode of operation. When in the constant-current mode, the output current will regulate to the set value and the output voltage will vary with the load. This is the normal operating mode for the SFA.
- 5 OVERCURRENT FAULT Indicator: Red LED indicates output current has exceeded preset level, and power supply output is turned off.
- 6 MODULE FAULT Indicator: Yellow LED indicates an internal fault such as bias supply, thermal, or converter failure.
- 7 SET/RESET OVERCURRENT PROTECTION Pushbutton: Depress button to view OCP level. Push and hold for 4 seconds to reset OCP condition.
- 8 CURRENT knob: 10-turn adjustment sets the output current. (Optional shaft locks not shown. Please see Section 3.1.1).
- 9 ON/OFF Switch: Two-position switch enables or disables the power supply.

**WARNING!**

The OFF position of the power switch does not remove voltage from the input terminal blocks. Remove all external power before servicing the unit.

Refer to Figure 3-2 and the corresponding descriptions below for an explanation of rear panel connectors.

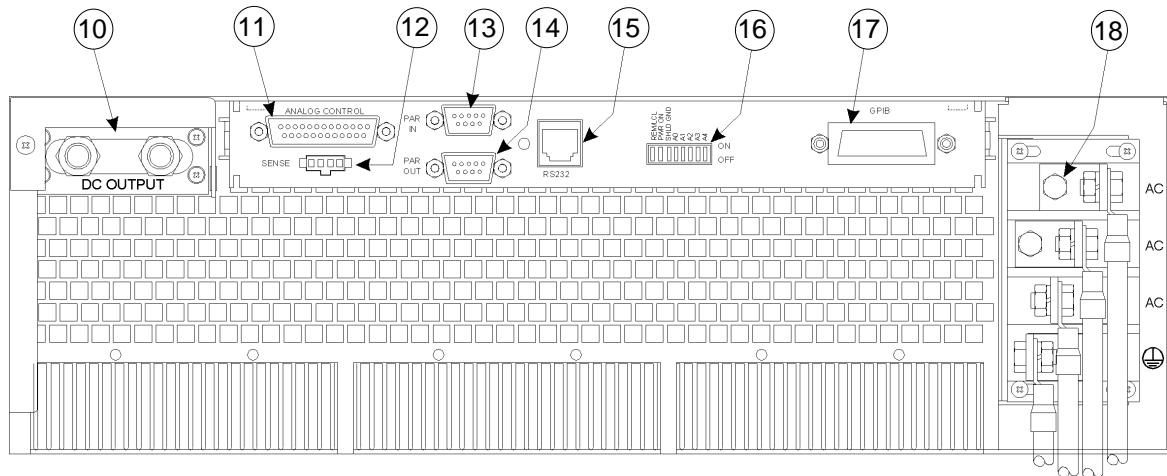

**Figure 3-2. Rear Panel Connectors (3U model shown)**

- 10 DC OUTPUT: Positive (+) and negative (–) outputs. Threaded studs for 5-15kW models; bus bars for 20-30kW models.
- 11 ANALOG CONTROL Connector (J1): I/O connector for input programming and analog output monitoring signals as well as status indication and remote shutdown signals. See Table 3–1 for individual pin descriptions.
- 12 SENSE Connector (J3): Input connector for load voltage sensing to provide a more accurate voltage measurement for remote voltage readback and front panel voltage meter display (see Section 3.4).
- 13 PARALLEL IN Connector: Allows master/slave configuration of up to five units when connected to another unit's PARALLEL OUT connector (see Section 3.8).
- 14 PARALLEL OUT Connector: Allows master/slave configuration of up to five units when connected to another unit's PARALLEL IN connector (see Section 3.8).
- 15 RS232 Connector: Optional RJ-11 connector for remote control.
- 16 Dipswitch: Eight–position dipswitch to configure an SFA Series unit with an IEEE option.
- 17 GPIB Connector: Optional connector for remote control.
- 18 AC Input Bus Bars: Connection for 3-phase AC and Ground.

### 3.1.1 SHAFT LOCK (OPTION)

This option replaces the standard control knob with a two-piece shaft lock. This is installed over the current adjustment potentiometer shaft to prevent rotating under conditions of shock, vibration, or accidental contact. For adjustment, the following steps apply:

1. Loosen the shaft by rotating the outer locking nut counter-clockwise with a 7/16-inch wrench.
2. Adjust the shaft with a flat screwdriver to the desired output level.
3. Tighten the outer locking nut, rotating clockwise, to approximately 5 LB-in (0.56 N-m).

**NOTE:** Take care not to over-torque the outer nut. Should the cone nut become loose or jammed with the outer locking nut, re-torque the cone nut with a 1/2-inch wrench to approximately 15 LB-in (1.69 N-m).

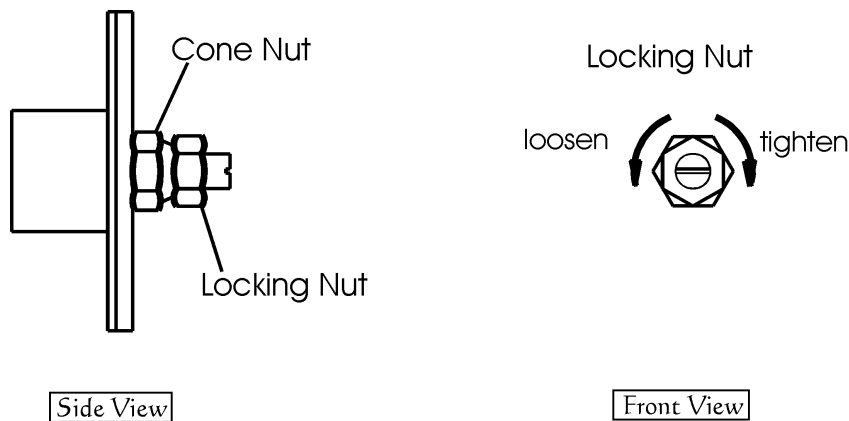

**Figure 3-3. Shaft Lock**



**CAUTION!**

Never completely loosen the cone nut, or remove the shaft lock from the chassis.

### 3.2 LOCAL OPERATION

The SFA Series power supply is shipped from the factory configured for local current control and local voltage sensing. The ANALOG CONTROL connector is supplied with a mating connector with remote ON/OFF jumpered for ON (terminal 5 shorted to terminal 6).

Prior to turning the unit on, rotate the current potentiometer fully counterclockwise (minimum output). Then, turn the power ON and adjust the current to the desired output.

This section provides an overview of front panel operation and initial functional tests of the power supply.

### 3.2.1 FLOATING AND POLARIZED OUTPUT

The SFA Series supply can be set up for a Positive or Negative supply, as well as standard operation as a floating output supply.

#### **FLOATING OUTPUT**

The output terminals are normally floating from chassis ground. No extra steps or connections are required for a floating output.

#### **POSITIVE SUPPLY SETUP**

Attach the negative output terminal to the supply chassis. The output reference is now chassis ground. When the output voltage is set or programmed, the supply will output a positive potential from chassis ground.

#### **NEGATIVE SUPPLY SETUP**

Attach the Positive output terminal to the supply chassis. The output reference is now chassis ground. When the output voltage is set or programmed, the supply will output a negative potential from chassis ground.



#### **CAUTION!**

Floating the negative output terminal floats the power supply's internal control circuitry common level to the same potential as the negative output terminal. On a standard non-isolated supply the common of the analog control connector (J1) floats at the same potential as the negative output terminal. Damage may occur if the non-isolated analog control connector of a supply is connected to an external ground referenced input/output device. Such a connection creates ground loop currents. To correct ground loop problems the Isolated Analog option is advised in order to isolate the external ground reference signals from the internal control circuitry of the supply.

### 3.2.2 INITIAL SETUP

Before connecting the unit to an AC outlet, ensure that the front panel ON/OFF power switch is in the off position and that the current control knob is fully counterclockwise. Check the ANALOG CONTROL (J1) mating connector on the rear panel to verify that pins 5 and 6 (Remote Output On/Off) are shorted together to enable the output of the supply (see Section 3.5). This is the default configuration installed from the factory. Apply power to the AC mains input.

### 3.2.3 CURRENT MODE OPERATION

When the supply is in the Current Mode (the default mode for the SFA Series), the output current of the supply is controlled by the Current knob on the front panel or by the remote current input (see Section 3.3). To verify operation in current mode, follow the steps below:

1. Connect a high current DC ammeter across the rear panel positive and negative output terminals, observing the correct polarity. Select wire leads of sufficient current carrying capacity and an ammeter range compatible with the units maximum rated output current. NOTE: If a high current ammeter is not available, you may simply short the output terminals together. This will not harm the supply.
2. Turn on the power supply.
3. Slowly rotate the Current knob clockwise and observe both the front panel current display and the output of the ammeter. The minimum range should be from 0A to the maximum rated current output of the supply. The front panel display and ammeter readings should track within the accuracies of the meter and the front panel display.
4. Note the reading on the voltage display. This is the compliance voltage of the load at the present output current. Note the maximum compliance voltage is set by the specific model of the supply.
5. Check that the green Current Mode indicator is on.
6. Turn the Current knob fully counterclockwise.
7. Turn the power supply off.
8. Disconnect the ammeter or short from the output terminals.

If Current mode operation did not function as indicated above, recheck your setup and perform the check again. If the function continues to fail, contact the factory for assistance.

### 3.2.4 OVERCURRENT PROTECTION

The Overcurrent Protection (OCP) function allows the supply to shutdown the output when it exceeds a preset current. This may be used to protect sensitive circuits or loads from damage caused by an excessive current on the output of the supply. To verify OCP operation, follow the steps below:

1. Connect a short or an appropriate load across the output terminals.
2. Rotate the Current control knob fully counterclockwise (this sets the current control at 0 Amps)
3. Turn on the power supply.



4. Press and hold the Set/Reset Overcurrent Protection pushbutton on the front panel and observe the reading on the current display. This is the present setting of the OCP limit. The factory default setting is approximately 110% of the maximum rated output of the supply.
5. While holding down the Set/Reset button, use a small adjustment screwdriver to adjust the OCP setting by turning the 4-turn recessed adjust potentiometer counterclockwise. As you adjust the potentiometer the reading on the current display should decrease (increase as you adjust in a clockwise direction).
6. Set the OCP to about 80-90% of the maximum rated output current and note the OCP current value. Release the Set/Reset pushbutton.
7. Rotate the Current knob clockwise until the current display indicates you are about 2-3% below the OCP voltage value noted above.
8. Slowly continue to increase the output of the supply until you exceed the value of the OCP setting. At this point the OCP light should turn on and the output of the supply will turn off causing the output to go to 0 volts (as indicated on the voltage display).
9. Turn the Current knob fully counterclockwise, then press and hold the Set/Reset pushbutton until the OCP light turns off.
10. Reset the OCP setting as appropriate for your application per steps 4 and 5 above. If you do not chose to use OCP, then the OCP adjust may be set fully clockwise to approximately 110% of the rated output current of the supply.

If OCP mode did not function as indicated above, recheck your setup and perform the check again. If the function continues to fail, contact the factory for assistance.

### 3.2.5 ANALOG CONTROL CONNECTOR (J1)

The ANALOG CONTROL connector on the rear panel allows the unit to be configured for different operating configurations: local and remote current programming, current and voltage output monitoring, output enable/disable, etc. The setup and operating requirements of each configuration are provided in Sections 3.3 through 3.7.

#### **ISOLATED ANALOG CONTROL (OPTION)**

The Isolated Analog Control uses the same Analog Control connector (J1). This option fully isolates remote control signals and allows control of units not connected to a common ground. Control ground is isolated from power ground, which protects against potential damage from systems with high electrical noise or large ground loop currents.

**NOTE:** Some standard analog programming signals may not be available with this option. See Table 1.2.2 for details.



**CAUTION!**  
 This option is not intended to allow operation of the power supply at excessive voltages. Refer to Section 2 INSTALLATION for maximum terminal voltages.

Following are Figure 3-4 with the connector's pin-out diagram, and Table 3–1 with ANALOG CONTROL connector designations and functions:

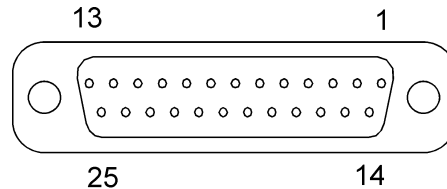

**Figure 3-4. ANALOG CONTROL Connector (J1) Pin-out**

Designator	Schematic Symbol	Electrical Chars.	Functional Description
1	ISO ON/OFF	Zin ~ 6 kΩ	Isolated remote on/off. Externally supplied AC/DC voltage source for on/off control. A positive (+) 12 to 240 VAC or 6 to 120 VDC voltage will turn on the supply. This input control is optically isolated from the power supply circuit up to 500 VDC. See Section 3.5.
2	ISO RTN	—	Isolated circuit return used with isolated on/off control J1-1 and J1-14.
3	REM OC SET	Zin ~ 20 kΩ	Remote overcurrent set. A remote signal sets the overcurrent trip level. 0-5.5 VDC = 0-110%. Apply a 10.5 VDC to 13.3 VDC signal for 4 seconds to reset an OCP condition. See Section 3.6.
4	Not Used		
5	ON/OFF	Must sink ~1mA to enable	Remote on/off. Switch/relay contacts or a direct short between this terminal and circuit common turns on the unit.
6	COM †	-	Circuit Common. Same potential as the negative output terminal.
7	I MON	Zout ~ 100Ω	Output current monitor. 0-10 VDC equals 0-100% rated current. Minimum load resistance 10kΩ.

Designator	Schematic Symbol	Electrical Chars.	Functional Description
8	Not Used		
9	Not Used		
10	IP 5V	$Z_{in} \sim 10k\Omega$	Remote current programming using a 0-5 VDC source. Do not exceed 13.3 VDC.
11	ISET <sup>*</sup>	$Z_{out} \sim 100\Omega$	0-5 VDC (0-100%) front panel current control monitor output. Minimum load resistance 10k $\Omega$ .
12	SENSE –	$\sim 1000\Omega$ to neg (–) output terminal	Remote Sense (–) on 60 volts output units. (For new installations, use J3, recommended only for backward compatibility in existing systems.)
13	SENSE +	$\sim 1000\Omega$ to pos (+) output terminal	Remote Sense (+) on <60 volts output units. (For new installations, use J3, recommended only for backward compatibility in existing systems.)
14	ISO TTL/CMOS	$Z_{in} \sim 2.2k\Omega$	Isolated TTL/CMOS on/off control. A high state TTL/CMOS voltage turns on the power supply, and a low state or open connection turns the supply off.
15	Not Used		
16	IP 10V	$Z_{in} \sim 20k\Omega$	Remote current programming using a 0-10 VDC source. Do not exceed 25 VDC.
17	FAULT	$Z_{out} \sim 100\Omega$	Fault state output. A high state (approximately +10 VDC) indicates a converter, temperature or bias supply fault, and the LED on the front panel will illuminate.
18	S/D FAULT	$Z_{out} \sim 100\Omega$	Shutdown fault. This terminal goes to high state in the event of converter, temperature, overvoltage or bias supply fault. A 7 VDC to 13.3 VDC signal can be applied to this pin to shutdown the output of the unit. An 8 VDC minimum output signal is provided into a 10 k $\Omega$ minimum load, in the event of an internally generated shutdown.
19	V MON	$Z_{out} \sim 100\Omega$	Output voltage monitor. 0-10 VDC equals to 0-100% rated voltage. Minimum load resistance 10k $\Omega$ .

Designator	Schematic Symbol	Electrical Chars.	Functional Description
20	Not Used		
21	Not Used		
22	IP RES <sup>*</sup>	~ 10.8V compliance	1 milliamp current source for remote current programming using resistance. 0-5k ohm resistor referenced to common will program the output from 0-100%.
23	IP RTN	Zin ~ 10kΩ	Current programming return. Used with J1-10, J1-16 or J1-22 and must be referenced to or within ±3V of the circuit common.
24	COM <sup>†</sup>	-	Circuit common. Same potential as the negative output terminal.
25	IP RTN	Zin ~ 10kΩ	Current programming return. Used with J1-10, J1-16 or J1-22 for remote current programming and must be referenced to or within ±3V of the circuit common.

**Table 3–1. ANALOG CONTROL Connector (J1), Designations and Functions**

<sup>†</sup> Control ground is isolated from power ground with the isolated analog control (option). See Section 3.2.5.1

<sup>\*</sup> Signals not available with isolated analog control (option).



**CAUTION!**  
 If standard analog programming is used, note the programming return (J1-6 & J1-24) is at the same potential as the negative output terminal of the power supply. Observance of return connections should be made with respect to input programming signal equipment. Improper connection may result in ground loops and as a result internal power supply damage may occur. (Output current then flows to chassis by means of external connection to the J1 common (J1-6 & J1-24)).

### 3.3 REMOTE CURRENT PROGRAMMING

Remote current programming is used for applications that require the output current be programmed (controlled) from a remote source. An external resistance or external voltage source may be used as a programming device. When using remote current programming, a shielded, twisted-pair, hookup wire is recommended to prevent noise interference with programming signals.

1. Remote Current Programming Using Resistance:

The resistance coefficient for remote current programming is 5k ohms/100% rated output with respect to terminal J1-23 (IP RTN). The programming current from terminal J1-22 (IP RES) is factory set for 1 milliampere. This yields a coefficient of 1.0% of rated output current for each 50 ohms. If multiple switches or relays are used to program different levels, make-before-break contacts are recommended. Note that if an external resistance is used for remote programming, the current programming return (IP RTN), terminal J1-23, must be connected directly to or within  $\pm 3$  volts (see note) of the power supply common terminal, J1-24. See Figure 3–5 for connection requirements.

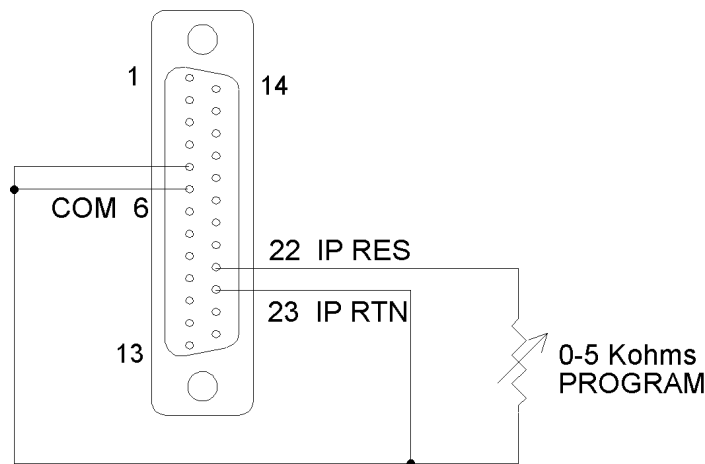
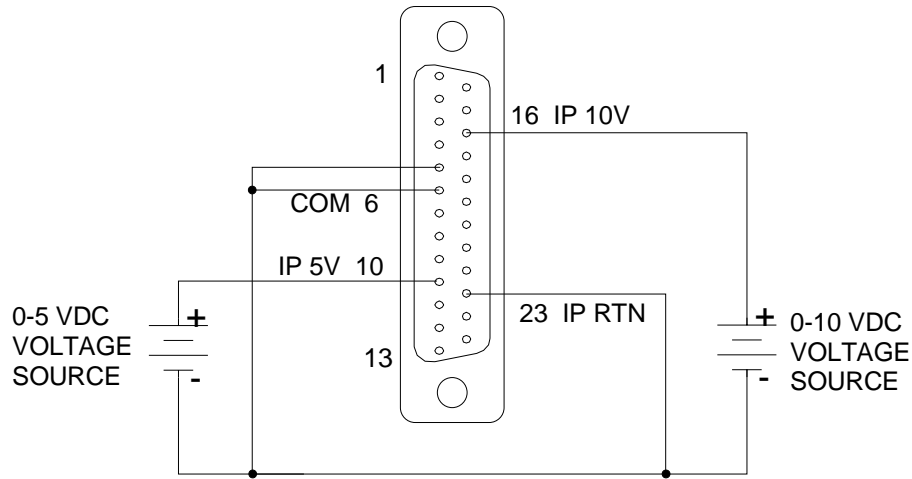

**Figure 3–5. Remote Current Programming Using Resistance**

2. Remote Current Programming Using a 0-5 VDC or 0-10 VDC Voltage Source:

A DC voltage source for remote current programming is connected between J1-10 (IP 5V) or J1-16 (IP 10V) and the return terminal J1-23 (IP RTN). Note that the return terminal J1-23 (IP RTN) must be referenced directly to or within  $\pm 3$ V (see note) of the power supply common, J1-24. The voltage coefficient for 5V remote current programming is 50 millivolts = 1% of rated output, i.e., for a 300 amp model, each 50 millivolts of programming voltage equals 3 amps of output current. The voltage coefficient for 10V remote current programming is 100 millivolts = 1% of rated output, i.e., for a 300 amp

model, each 100 millivolts of programming voltage equals 3 amps of output current. See Figure 3–6 for connection requirements.



**Figure 3–6. Remote Current Programming Using 0-5 VDC or 0-10 VDC Voltage Source**

### 3.4 REMOTE SENSING

Remote voltage sensing is recommended for accurate voltage measurement, whether you connect sensing leads to the load or directly to the output terminals. This will provide the most accurate voltage readback and front panel voltage meter display.



**CAUTION!**

If the power supply is operated with load power lines disconnected and sensing line connected, internal power supply damage may occur. (Output current then flows through sensing terminals.)

To use remote voltage sensing, connect the power supply as described below. See Figure 3–7 for connection requirements.

Connect sensing leads from the load positive to J3-1 and the load negative to J3-2. A shielded, twisted-pair, hookup wire is recommended to avoid potential noise interference.

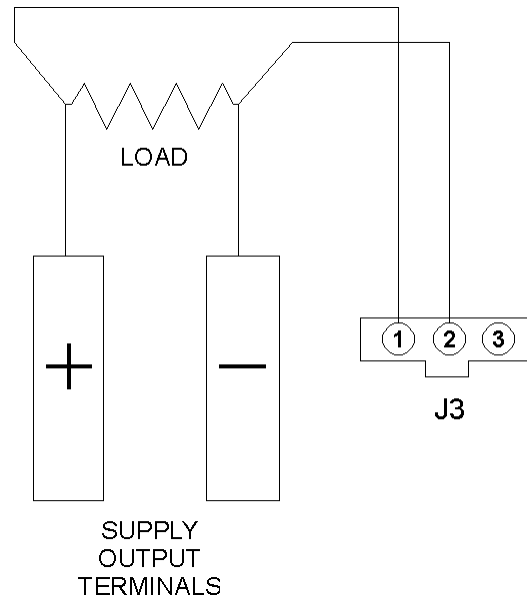

**Figure 3-7. Remote Sensing Operation at the Load \***

\* For accurate measurements through remote voltage readback and front panel voltage meter display.

### 3.5 REMOTE OUTPUT ON/OFF CONTROL

Remote on/off control may be accomplished by contact closure or by an isolated external AC/DC or TTL/CMOS voltage source.

1. Remote on/off by contact closure. Output is on when contacts (J1-5 and J1-6) are closed. See Figure 3–8 for connection requirements.

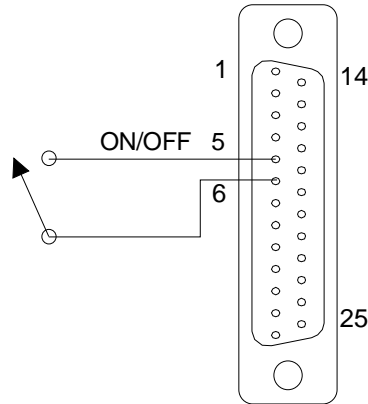

**Figure 3–8. Remote On/Off Control by Contact Closure**

2. Remote on/off control may be accomplished by an external 12 to 240 VAC or 6 to 120 VDC or TTL/CMOS source. Application of AC/DC or high state TTL/CMOS voltage will turn on the power supply. See Figure 3–9 and Figure 3–10 for connection requirements.

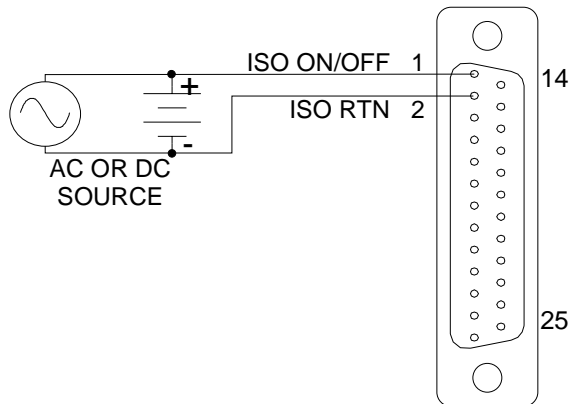

**Figure 3–9. Remote On/Off Using Isolated AC or DC Voltage Source**



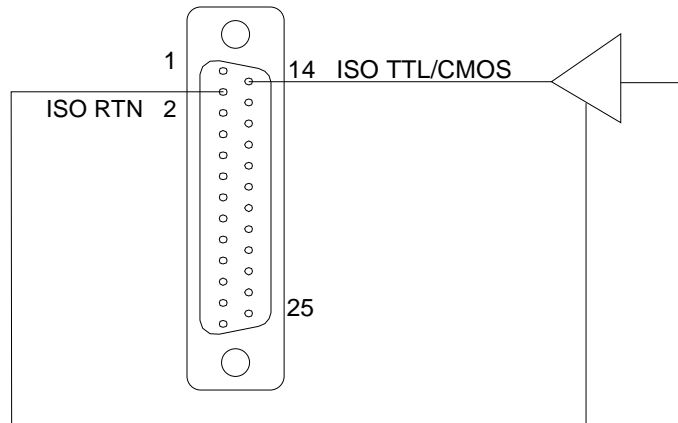

**Figure 3–10. Remote On/Off Using Isolated TTL/CMOS Voltage Supply**

### 3.6 REMOTE OVERCURRENT SETPOINT



**CAUTION!**

Do not program the remote overcurrent set point greater than 10% (5.5V) above the power supply rated current (except as noted) as internal power supply damage may occur.

A remote DC voltage source can be connected externally between terminals J1-6 (COM) and J1-3 (REM OC SET) to set the output overcurrent trip level. A 0-5.5 VDC signal equals 0-110% of rated output voltage. See *Figure 3–11* for connection requirements.

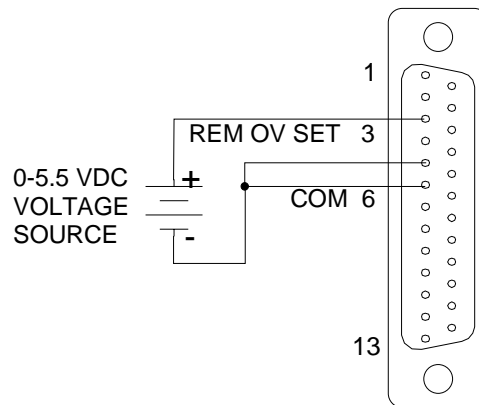
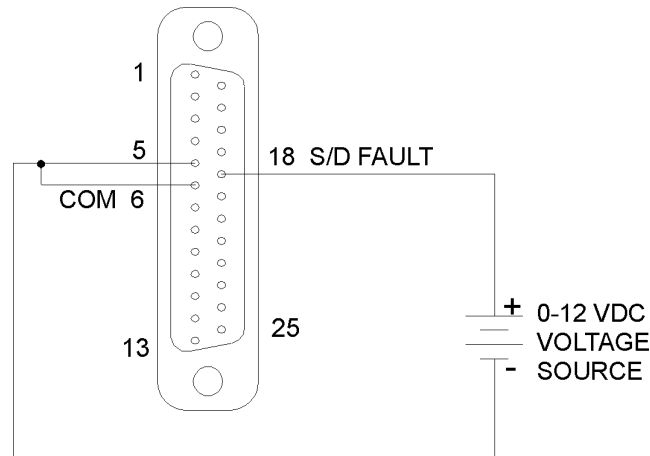

**Figure 3–11. Remote Overcurrent Set Using DC Voltage Source**

**NOTE:** The Remote OCP trip level will ALWAYS take precedence over the local trip level, even if the local OCP trip level is set to a lower value. To reset an OCP externally, apply a 10.5–13.3 VDC signal to J1-3 for a minimum of four (4) seconds.

### 3.7 REMOTE SHUTDOWN (S/D)

A remote +12 VDC voltage can be connected externally between terminals J1-18 (S/D Fault) and J1-24 (COM) to disable, i.e., shut down the output of the power supply. Disabling or opening the +12 VDC signal will allow the unit to revert to normal operation.



**Figure 3–12. Remote Shutdown Using DC Voltage Source**

### 3.8 MASTER/SLAVE OPERATION

The following modes of operation are used for applications requiring more current or voltage than is available from a single power supply. To meet the requirements for greater output voltage or current, up to five supplies may be connected in parallel.

#### 3.8.1 PARALLEL OPERATION

In the parallel mode of operation, a master/slave configuration is established. Up to five power supplies may be paralleled using this configuration. To set up the parallel mode of operation, connect the interface cable (P/N 890-453-03) from the master unit to the slave unit(s), as shown below in Figure 3–13. Next connect the positive outputs of supplies together and the negative outputs of the supplies together. It is recommended that the outputs are connected together as close to the load as practical.

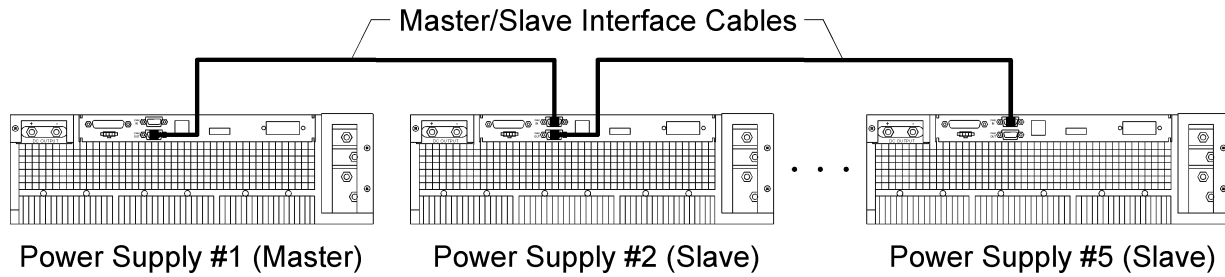

**Figure 3–13. Master/Slave Connection**

**NOTE:** The OCP circuit remains active for all units in parallel operation. If the units are set to different OCP levels, the paralleled system will trip according to the lowest setting. For ease of use, adjust the OCP levels for the slaves to maximum and adjust the master OCP level to the desired setting.

This page intentionally left blank.

# SECTION 4

## VERIFICATION AND CALIBRATION

### 4.1 INTRODUCTION

This section provides verification and calibration procedures for the standard SFA Series power supplies and isolated analog control (option).

#### 4.1.1 VERIFICATION AND CALIBRATION CYCLE

It is recommended that the power supply be calibrated and/or verified once each year of operation.

#### 4.1.2 PREPARATION



#### WARNING!

Hazardous voltages exist on the rear of the supply. Great care must be taken to avoid both the input terminals, and while the supply is enabled, the output terminals. Only authorized personnel should perform this procedure.

Due to the importance of accurate readings to performance, only technically trained personnel should perform calibration procedures.

The calibration and adjustment procedures require two digital multimeters. To set up for the calibration procedures, first perform the following:

1. Remove prime AC power.
2. Connect the power supply to a precision current shunt (as shown in Figure 4-1 below) capable of a minimum of 10% above full rated output. A fan may be required to cool the shunt.

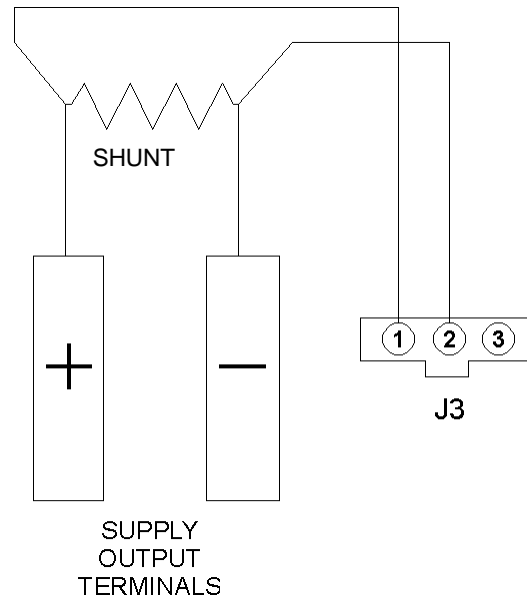

**Figure 4-1. Precision Current Shunt**

## 4.2 STANDARD VERIFICATION AND CALIBRATION PROCEDURE

All calibration potentiometers can be adjusted through access holes in the top cover of the SFA Series unit. It is **not** necessary to remove the top cover to perform the calibration procedures.

### 4.2.1 CURRENT MODE

1. Set the SFA Series unit to operate in remote current programming mode using an external 0-5 Vdc voltage source as shown in Figure 3–6 in Section 3.3 Remote Current Programming.
2. Attach a precision meter across the shunt Kelvin terminals.
3. Attach a precision meter in parallel with the voltage programming source.
4. Set the voltage source to  $0.0V \pm 1mV$ .
5. Apply AC power and verify the current mode indicator is illuminated.
6. Verify the unit is set to  $0A \pm 0.8\%$  of full-scale output. If necessary, adjust R55 for zero current through the shunt. (See Figure 4-2.)
7. Set the programming voltage to  $5.0V \pm 1mV$ .
8. Verify the unit is set to  $100\% \pm 0.8\%$  of full-scale output current. If necessary, adjust R69 for 100% of full-scale current on the shunt.

9. Set the programming source for  $0.5V \pm 1mV$ .
10. Verify the unit is set to  $10\% \pm 0.8\%$  of full-scale output current. If necessary, adjust R55 for 10% of full-scale current on the shunt.
11. Repeat the steps above as required to obtain the required accuracy.
12. Set the programming source to obtain 100% output current on the shunt. Verify that the front panel meter displays  $100\% \pm 1\%$  of full-scale output current. If necessary adjust R85 such that the current display reads 100% current.

**CAUTION!**

Hazardous voltages may be present on the output after the output is disabled due to stored capacitive charge. Allow 5 minutes to drain the output capacitive charge to safe levels before connecting or removing output wiring.

#### 4.2.2 RESISTOR PROGRAMMING CURRENT SOURCES

1. Disable AC power to the unit. Turn the front panel Current knob fully counterclockwise.
2. Connect the power supply to a precision current shunt (see Figure 4-1, Section 4.1.2 Preparation).
3. Set the SFA Series unit to operate in remote current programming mode using resistance by connecting a 5K ohm (1% or better tolerance) resistor as shown in Figure 3–5 in Section 3.3 Remote Current Programming.
4. Attach a precision meter across the shunt Kelvin terminals.
5. Apply AC power and enable the unit via the front panel On/Off switch.
6. Verify there is  $5V \pm 1\%$  across the resistor. If necessary, adjust R45 to measure 5.00V read back on the voltmeter.
7. Disable AC power to the unit.
8. Remove all connections to the remote analog control connector (J1), except the jumper between pins 5 and 6.

#### 4.3 ISOLATED ANALOG (OPTION) VERIFICATION AND CALIBRATION PROCEDURE

All calibration potentiometers can be adjusted through access holes in the top cover of the SFA Series unit. It is **not** necessary to remove the top cover to perform the calibration procedures.

### 4.3.1 CURRENT MODE

1. Set the SFA Series unit to operate in remote current programming mode using an external 0-5 Vdc voltage source as shown in Figure 3–6 in Section 3.3 Remote Current Programming.
2. Attach a precision meter across the shunt Kelvin terminals.
3. Attach a precision meter in parallel with the voltage programming source.
4. Set the voltage source to  $0.0V \pm 1mV$ .
5. Apply AC power and verify the current mode indicator is illuminated.
6. Verify that the unit is set to  $0A \pm 0.8%$  of full-scale output. If necessary, adjust R47 for zero current through the shunt (see Figure 4-1 in Section 4.1.2 Preparation).
7. Set the programming voltage to  $5.0V \pm 1mV$ .
8. Verify that the unit is set to  $100% \pm 0.8%$  of full scale output current. If necessary, adjust R33 for 100% of full scale current on the shunt.
9. Set the programming source for  $0.5V \pm 1mV$ .
10. Verify that the unit is set to  $10% \pm 0.8%$  of full scale output current. If necessary, adjust R47 for 10% of full scale current on the shunt.
11. Repeat the steps above as required to obtain the required accuracy.
12. Set the programming source to obtain 100% output current on the shunt. Verify that the front panel meter displays  $100% \pm 1%$  of full-scale output current. If necessary adjust R85 such that the current display reads 100% current.

**CAUTION!**

Hazardous voltages may be present on the output after the output is disabled. Allow 5 minutes to drain any charge to safe levels before connecting or removing output wiring.



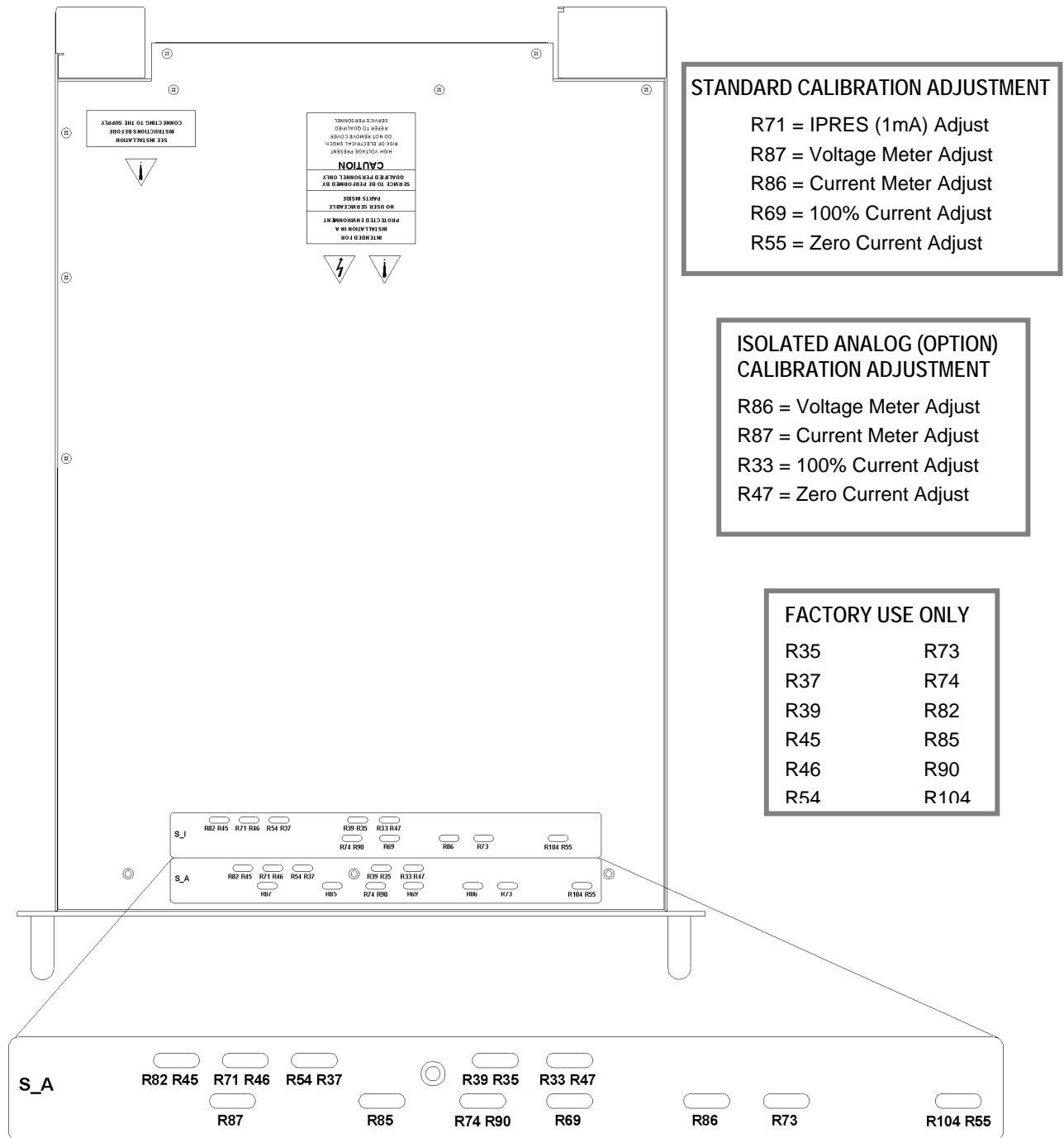

Figure 4-2. Potentiometer Locations

This page intentionally left blank.

# SECTION 5 MAINTENANCE

## 5.1 INTRODUCTION

This chapter contains preventive maintenance information for the SFA Series power supplies.



### WARNING!

All maintenance that requires removal of the cover of the unit should only be done by properly trained and qualified personnel. Hazardous voltages exist inside the unit. Disconnect the supply from the input power before performing any maintenance. Service, fuse verification, and connection of wiring to the chassis must be accomplished at least *five minutes* after power has been removed via external means; all circuits and/or terminals to be touched must be safety grounded to the chassis.

## 5.2 PREVENTIVE MAINTENANCE

No routine maintenance on the SFA Series is required, aside from periodic cleaning of the unit when needed:

- Once a unit is removed from service, vacuum all air vents, including the front panel grill. Clean the exterior with a mild solution of detergent and water. Apply the solution onto a soft cloth, not directly to the surface of the unit. To prevent damage to materials, do not use aromatic hydrocarbons or chlorinated solvents for cleaning.
- Low-pressure compressed air may be used to remove dust from in and around components on the printed circuit boards.



### WARNING!

The OFF position of the power switch does not remove voltage from the input terminal blocks. Remove all external power before performing any service.

An annual inspection of the SFA Series unit is recommended. Table 5–1 lists the visual inspection checks to be performed, and the corrective action to be taken.

**Table 5–1. Recommended Annual Inspection**

Item	Inspect For	Corrective Action
External connector plugs and jacks	Looseness, bent or corroded contacts, damage or improper seating in mating connector	Clean contacts with solvent moistened cloth, soft bristle brush, small vacuum, or low compressed air.
		Replace connectors damaged, deeply corroded, or improperly seated in mating connector.
Chassis, fan, and extruded heatsinks	Dirt and corrosion	Clean with cloth moistened with soapy water.
External electrical wiring	Broken, burned or pinched wire; frayed, worn or missing insulation	Repair or replace defective wires.
External solder connections	Corrosion, loose, cracked, or dirty connections	Clean and resolder connections.
Dirt and moisture buildup	Short circuits, arcing, corrosion, overheating	Clean as required.
Front panel controls and meters	Dirt and corrosion	Clean with cloth moistened with soapy water.
		Use a Kimwipe tissue and GTC glass-cleaning compound to clean the meter faces.



**CAUTION!**

For safe and continued operation of the SFA Series, always operate the unit in a temperature and humidity controlled, indoor area, free of conductive contaminants. Remember to keep the rear and sides of the unit free of obstructions to ensure proper ventilation.

## 5.3 FUSES

There are no user replaceable components in the power supply.



### WARNING!

Only properly trained and qualified personnel should remove the cover from the power supply. Service, fuse verification, and connection of wiring to the chassis must be accomplished at least *five minutes* after power has been removed via external means; all circuits and/or terminals to be touched must be safety grounded to the chassis.



### CAUTION!

To reduce the risk of fire or electrical shock, replace fuses only with the same type and rating.

Internal fuses are listed in Table 5–2. Note, however, that failure of one of these fuses indicates a more serious problem has occurred. Please contact the factory for further assistance.

PCB Part No.	Reference	Value	Manufacturer Part No.
Bias Supply	F1, F2, F3	600 Volt, 5 Amp	Littelfuse KLK-5
Module Controller	F1	600 Volt, 30 Amp	Littelfuse KLKD30

**Table 5–2. Fuse Values**

This page intentionally left blank.

# INDEX

- C
  - Circuit Breaker Requirements, 2-2, 2-5
  - Controls and Indicators, 3-1
    - Analog Control (J1), 3-7
  - Current Mode
    - Operation, 3-6
    - Verification and Calibration, 4-2
- F
  - Fuses, 5-3
- I
  - Inductive Loads, 2-8
  - Input/Output Connections, 2-2
    - Connector Functions, 2-4
  - Isolated Analog Control, 3-7
- J
  - J1 Connector, 3-7
- L
  - Loads
    - Inductive, 2-8
  - Location and Mounting, 2-3
- M
  - Maintenance
    - Annual Inspection, 5-2
    - Fuses, 5-3
    - Preventive, 5-1
    - Master/Slave Operation, 3-16
    - Mounting Hardware, 2-3
- O
  - Operation
    - Current Mode, 3-6
    - Local, 3-4
    - Master/Slave, 3-16
    - Parallel, 3-16
    - Remote Current Programming, 3-11
    - Remote Output On/Off Control, 3-14
    - Remote Overvoltage Setpoint, 3-15
    - Remote Sensing, 3-12
    - Remote Shutdown, 3-16
  - Overvoltage Protection, 3-6
  - Ozone Precaution, 2-2
- P
  - Parallel Operation, 3-16
  - Potentiometer Locations, 4-5
- R
  - Rack slides, 2-3
  - Remote Current Programming, 3-11
  - Remote Output On/Off Control, 3-14
  - Remote Overvoltage Setpoint, 3-15
  - Remote Sensing, 3-12
  - Remote Shutdown, 3-16

## S

Setup, 3-5  
Shaft Lock, 3-4  
Specifications, 1-2  
    Current, 1-4  
    Electrical Characteristics, 1-3  
    Environmental Characteristics, 1-2  
    Noise, 1-4  
    Physical Characteristics, 1-5  
    Ripple, 1-4  
    Voltage, 1-4

## V

Ventilation, 2-3  
Verification and Calibration, 4-2  
    Current Mode, 4-2

## W

Wire Size, 2-6